



DE VLOEI IEPER:
WONINGEN
ZONE 4 TYPE 3

de**VLOEI** 

WVI
www.wvi.be

BARON RUZETTELAAN 35
8310 BRUGGE

T +32 50 36 71 71
E wvi@wvi.be

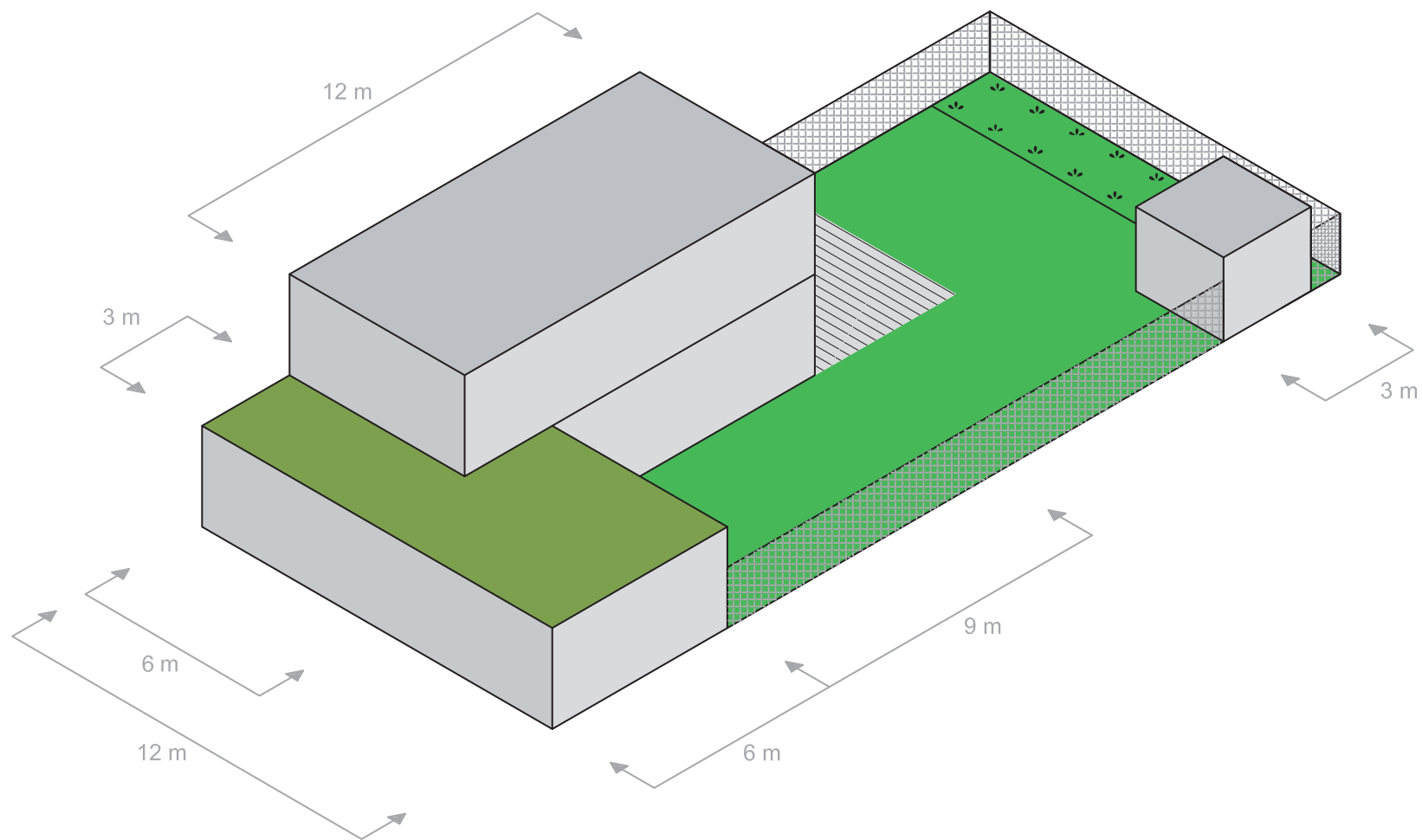

DE VLOEI IEPER:
WONINGEN
ZONE 4 TYPE 3

deVLOEI 

WVI
www.wvi.be

BARON RUZETTELAAN 35
8310 BRUGGE

T +32 50 36 71 71
E wvi@wvi.be

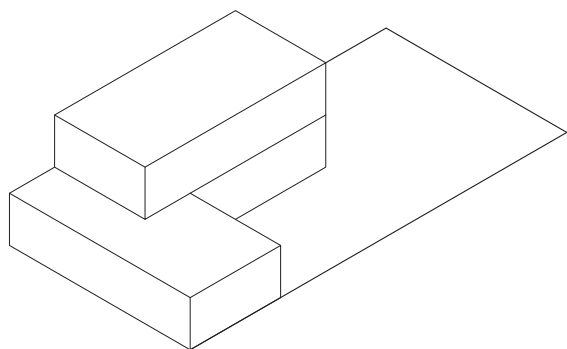

maximaal bouwvolume

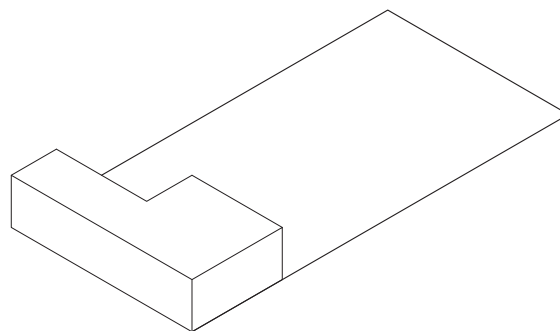

sokkel

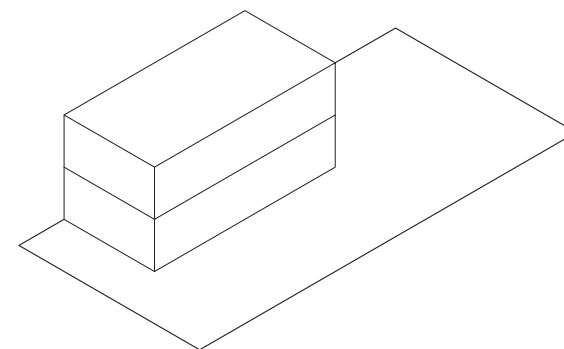

hoofdvolume

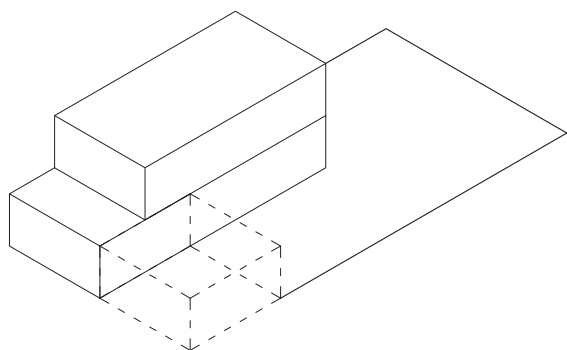

1x max. 50% uit de sokkel

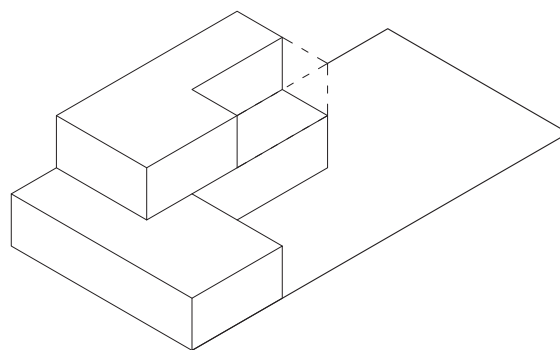

1x max. 25% uit het hoofdvolume

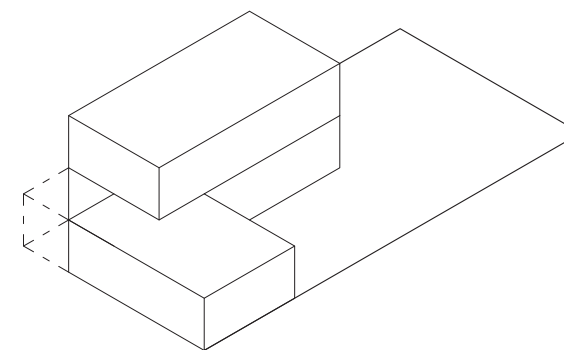

1x max. 25% uit de sokkel



DE VLOEI IEPER:
WONINGEN
ZONE 4 TYPE 3



WVI
www.wvi.be

BARON RUZETTELAAN 35
8310 BRUGGE

T +32 50 36 71 71
E wvi@wvi.be

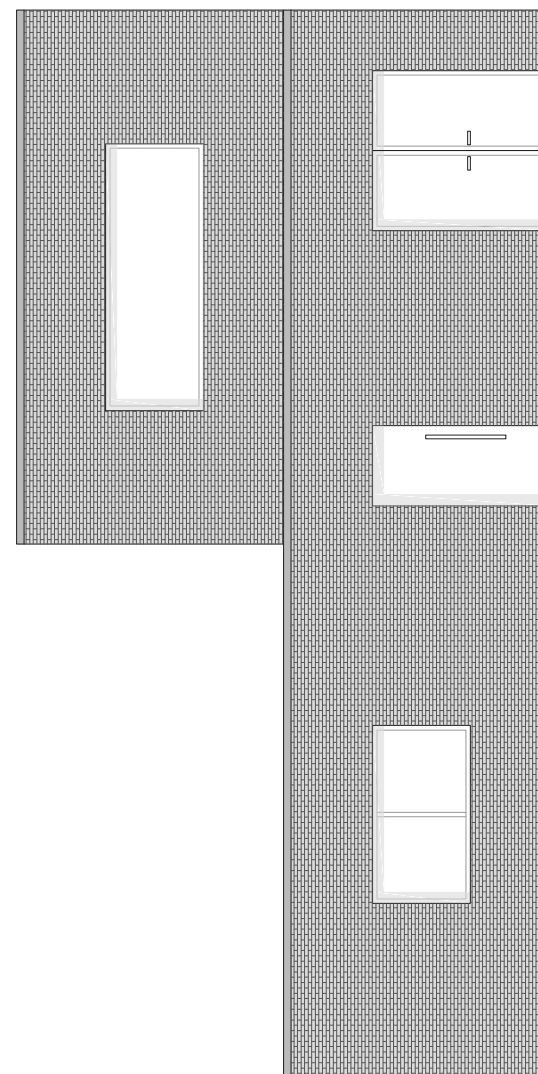
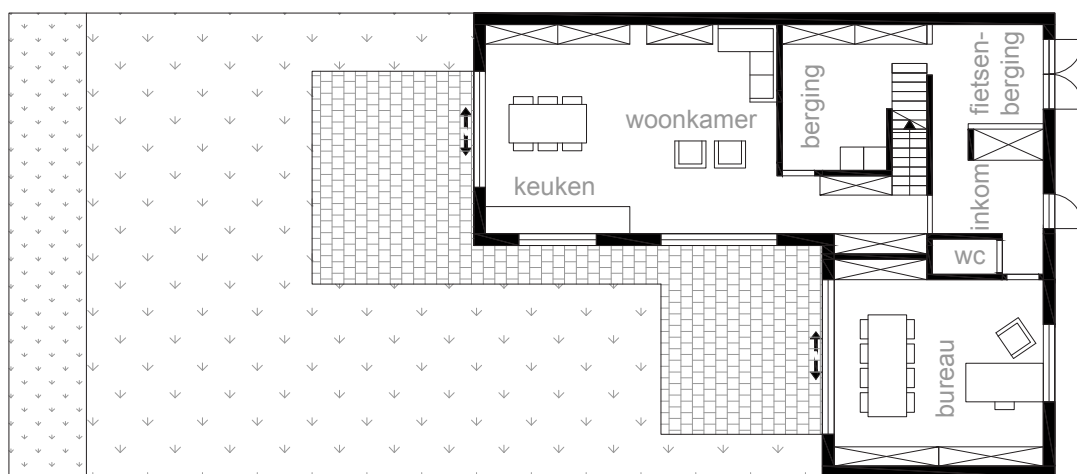
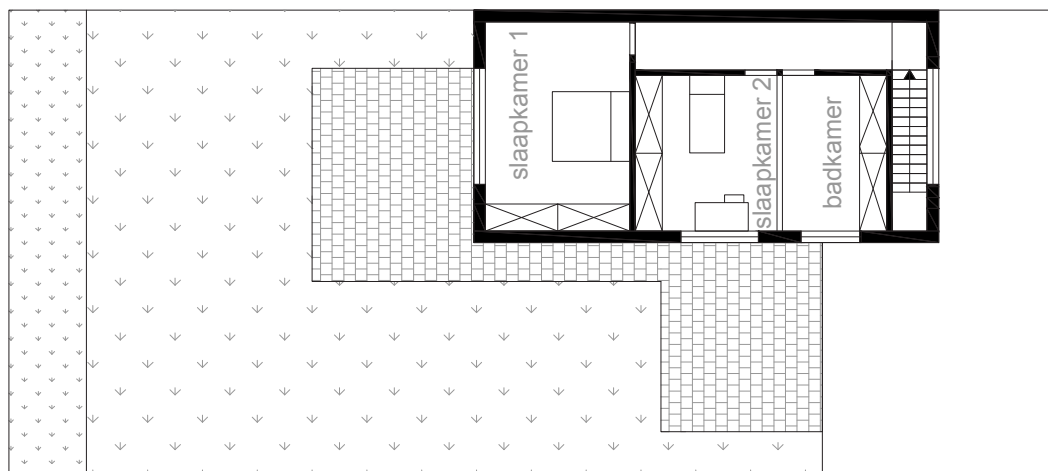

suggestie gevel woningen binnengebied XI: kleurenkaart 1



DE VLOEI IEPER:
WONINGEN
ZONE 4 TYPE 3

deVLOEI 

WVI
www.wvi.be

BARON RUZETTELAAN 35
8310 BRUGGE

T +32 50 36 71 71
E wvi@wvi.be

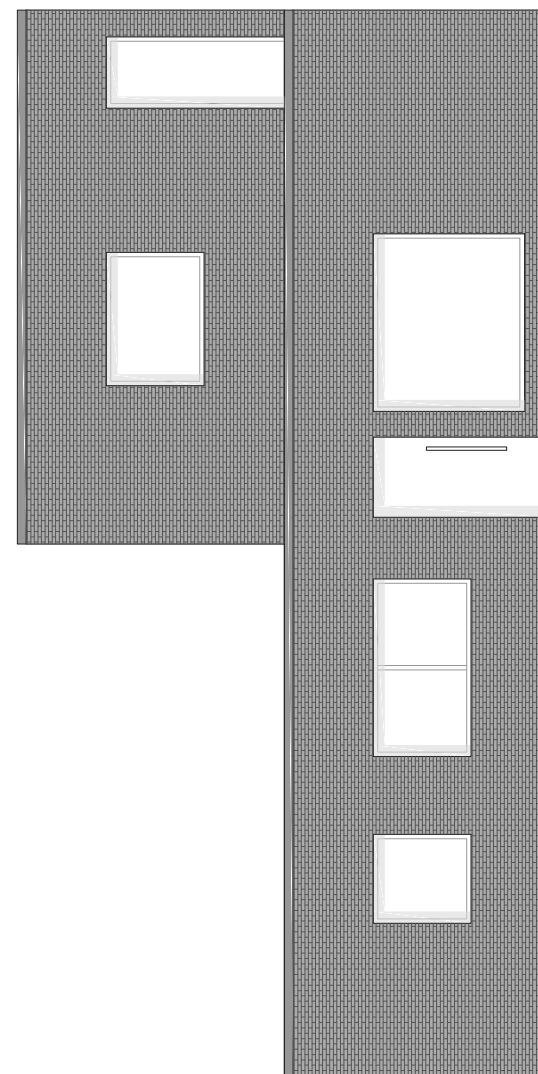
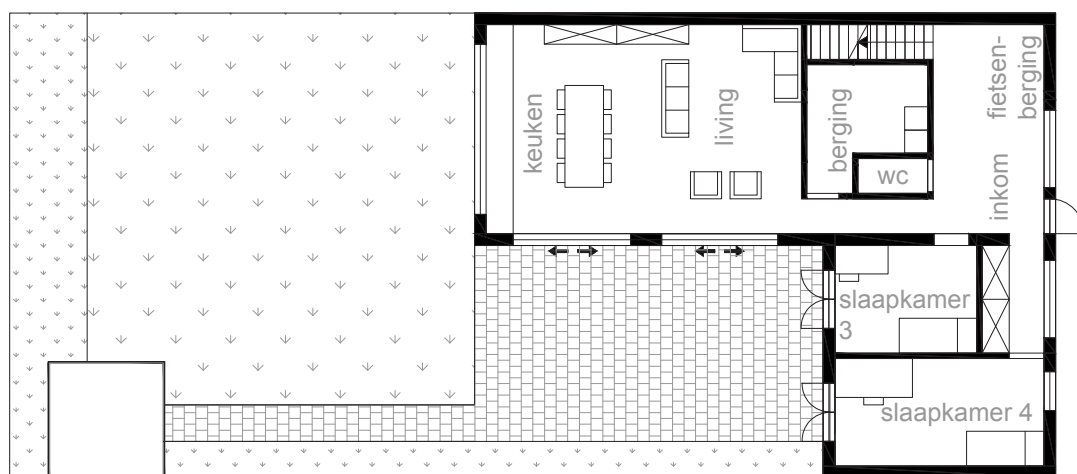
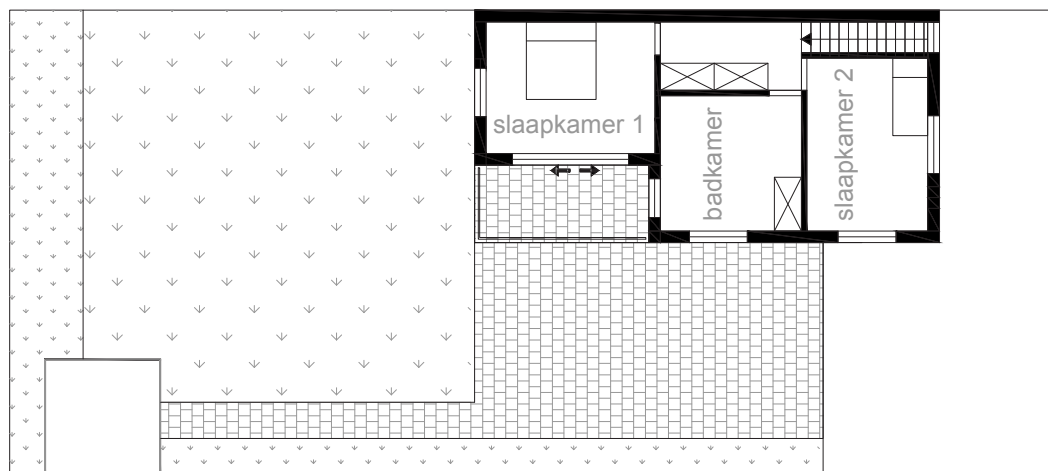

suggestie gevel woningen binnengebied XI: kleurenkaart 1



DE VLOEI IEPER:
WONINGEN
ZONE 4 TYPE 3

deVLOEI 

WVI
www.wvi.be

BARON RUZETTELAAN 35
8310 BRUGGE

T +32 50 36 71 71
E wvi@wvi.be

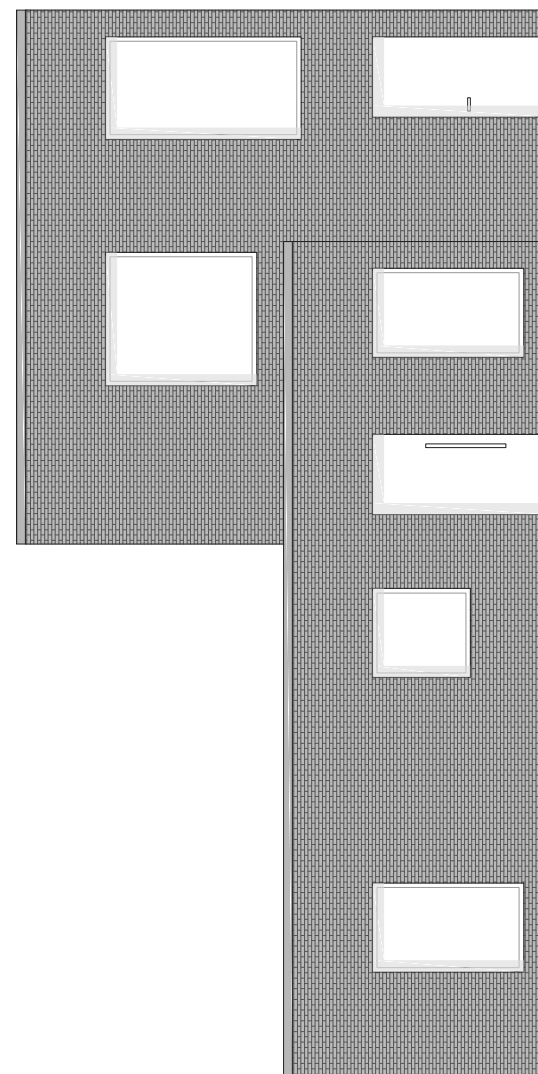
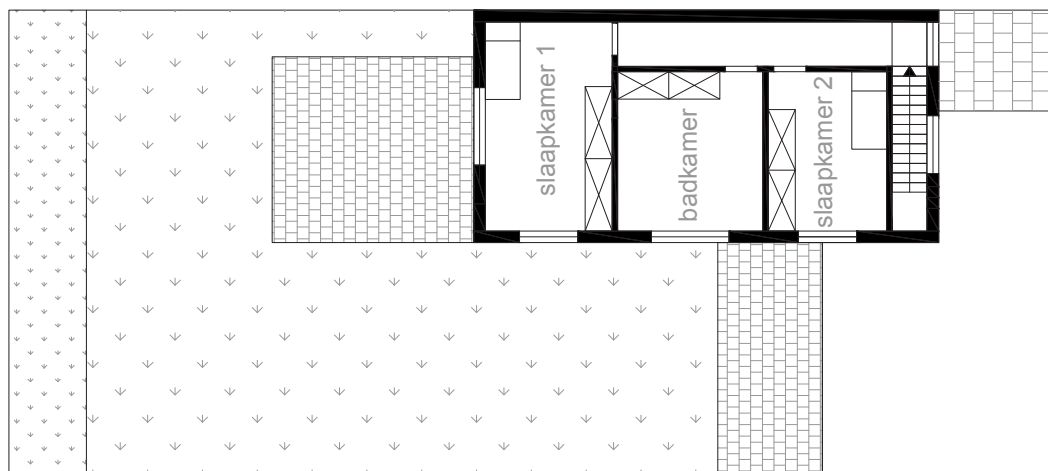

suggestie gevel woningen binnengebied XI: kleurenkaart 1



DE VLOEI IEPER:
WONINGEN
ZONE 4 TYPE 3

deVLOEI 

WVI
www.wvi.be

BARON RUZETTELAAN 35
8310 BRUGGE

T +32 50 36 71 71
E wvi@wvi.be



In totaal ca. 165
parkeerplaatsen
verspreid over de
parkeerhavens



DE VLOEI IEPER:
WONINGEN
ZONE 4 TYPE 3

deVLOEI 

WVI
www.wvi.be

BARON RUZETTELAAN 35
8310 BRUGGE

T +32 50 36 71 71
E wvi@wvi.be